



DATE:	PROJECT:
TYPE:	CATALOG:

P9 | PATH LIGHT
 PATHWAY/AREA LIGHTS | 20.50"H
 2 W (170lm) | 10.5-16 VAC | Integrated LED



FEATURES

- U.S.-made light engine and driver.
- CNC-machined, corrosion-resistant 6061 aluminum or C360 Brass.
- Dimmable configurations available; see Specifications and ordering guide for details. Standard fixtures are non-dimmable.
- Serviceable and upgradeable light engine for future technology enhancements.
- Optional factory-installed hex louver available to reduce glare and direct source visibility in direct-view applications.
- Built-in surge protector safeguards internal electronics from voltage fluctuations and power surges.
- High-performance 3-step bin LED with an L70 rating of over 100,000 hours.
- [20-year manufacturer limited warranty.](#)
- ETL listed to the UL 1838 standard, with IES files available (See page 4).
- 3000K fixtures available in all finishes, wattages, and optics, in stock and ready to ship. Other color temperatures are non-stock and require a lead time of 5-7 business days.

AVAILABLE FINISHES:

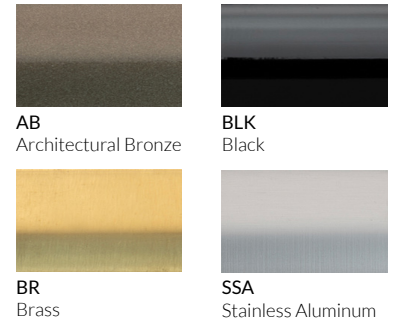

POWER CONSUMPTION

Candela Power & IES charts can be found on page 4

COLOR TEMPERATURE	WATTAGE	VA	LUMENS	ADDITIONAL COLOR TEMP OPTIONS	
● 3000K*	2W	5VA	170LM	● 2700K ● Amber ● Royal Blue ● Red	● 5000K ● Blue ● Green

* Indicates stocked items. Non-stocked items require 5-7 business days additional lead time, special order deposit and are non-refundable.

SPECIFICATIONS

Materials

CNC-machined from billet 6061-T6 aluminum or C360 brass with 316 stainless steel hardware.

Finish

BR: Raw, brushed brass; will tarnish/patina naturally.

BLK/AB: Corrosion-resistant E-coat primer under a hard enamel finish that delivers strong UV protection.

SSA: Marine-grade anodization for lasting corrosion resistance and durability.

Louver Option

Optional factory-installed hex louver reduces glare and direct source visibility in direct-view applications. Use of louver will result in a reduction of delivered light output.

Wattage

2W delivering up to 170 lm.

Voltage

10.5-16VAC. Requires low voltage transformer or step down transformer.

Light Engine

US Built Led module with Cree Diode and Metal core PCB for better heat dissipation.

CRI 80 (CRI 90 upon request) CCT 2700K & 3000K. McAdam 3 step LED binning to ensure color consistency.

Optics

Interchangeable optics available in 12°, 25°, 40°, and 60° beam angles.

Lead Wire

46" 22 AWG tinned copper.

Dimming Options

Standard fixtures are non dimmable. Dimmable Option valuable with constant current LED power supply connected in series with the fixtures.

Dimming Method: Phase Dimming (TRIAC/ELV) or 0-10V dimming.

Mounting

Comes standard with the LV131 stake and a pre-installed 1/2" - 14 NPS ABS male fitting (1 3/8" H), compatible with all Garden Light LED mounting accessories. (See page 2 for details).

Certifications & Ratings

ETL listed to UL1838, IP66 Standard.



P9 | Path Light

PATHWAY/AREA LIGHTS

ORDERING GUIDE

EXAMPLE: P9 204 BR 2700K HCL

MODEL

P9 P9 Path Light Light Fully Integrated	WATTAGE DIM (Dimmable) 20 (2W)	OPTICS 1 (12°) 2 (25°) 4 (40°) 6 (60°)	FINISH AB (Architectural Bronze) BLK (Black) BR (Brass) SSA (Stainless Aluminum)	COLOR TEMPERATURE 3000K (Default/Blank) 2700K 5000K AMB (Amber) BLU (Blue) RBL (Royal Blue) GRN (Green) RED (Red)
--	---	---	---	--

OPTIONAL ACCESSORIES

Accessory images & dimensions can be found on page 3

Mounting

LOUVER HCL (Hex Cell Louver)	GROUND MOUNT LV131 (LV131 Stake (Included/Blank)) LV180 (LV180 Stake) LV150 (LV150 Heavy Duty Stake 4"D X 19"H) SURFACE MOUNT MMB XXX (Mini Universal Mounting Base 2.375" Diameter x 1" H)	Extensions EXT6 XXX (6" Extension) EXT12 XXX (12" Extension) EXT20 XXX (20" Extension) EXT30 XXX (30" Extension)
--	--	---

* XXX represents color/finish option

TRANSFORMERS

BUILD THE SKU LEFT → RIGHT

Pattern: [WATTAGE (VA)]-[MODEL]-[CONNECTION TYPE]

Items tagged "(Default/Blank)" are not included in the SKU.

EXAMPLE: 602-WLED SS-DW

WATTAGE (VA) 62 102 152 302 602 902 1202 60WNL 60	MODEL WLED SS (Low Voltage Magnetic Transformer 15V Tap W/ LED & Surge Protection) INLINE (60W No-Load Inline Electronic Transformer 120VAC) Input, 12VAC Output) MD (Mammoth Dynamics phase-dimmable constant current driver (DC))	CONNECTION TYPE Pluggable 120VAC Plug-In (Default/Blank) DW (Direct Wire 120VAC) Direct Wire 120VAC (Default/Blank) Direct Wire 120VAC (Default/Blank)
---	---	---



FIXTURE DRAWINGS

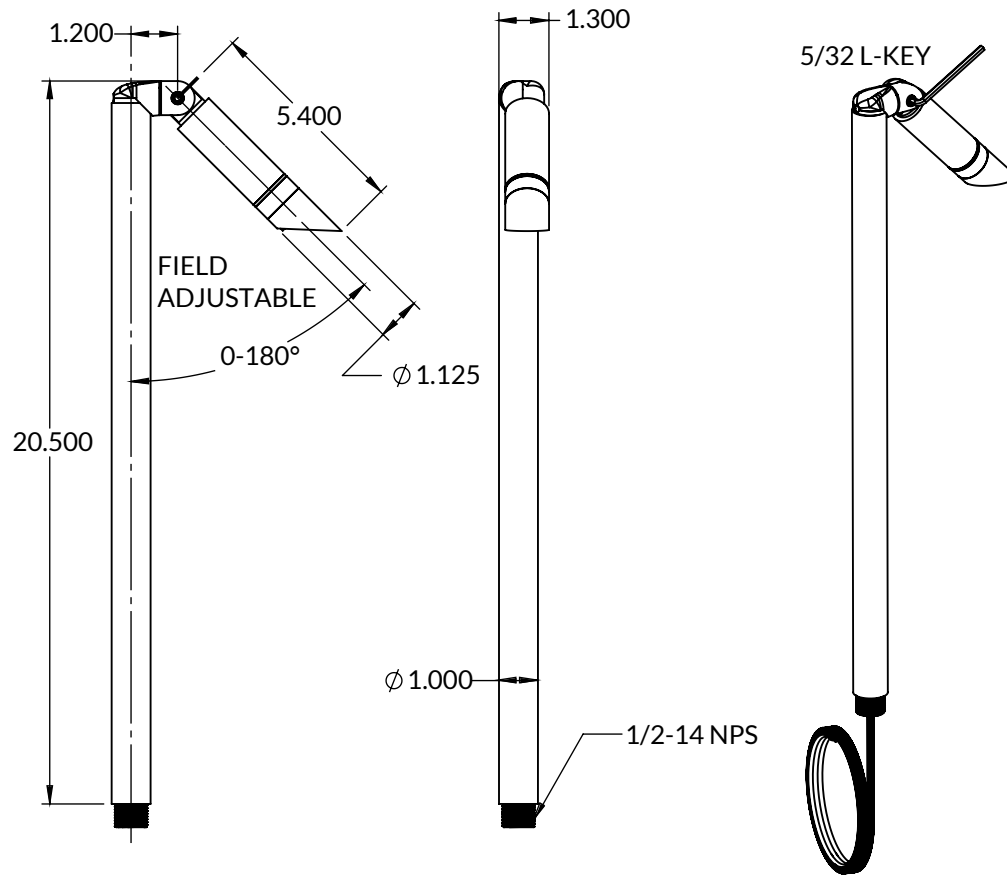

OPTIONS & ACCESSORIES

Louver Options:

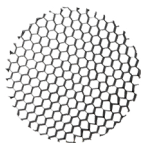

HONEY COMB LOUVER

Extensions:



[6" EXTENSION](#)



[12" EXTENSION](#)



[20" EXTENSION](#)

MOUNTING OPTIONS

Ground Mount:



[LV131 STAKE](#)



[LV180 STAKE](#)



[LV150 STAKE](#)

Building/
Structure
Mount:



[MINI UNI MOUNTING BASE](#)



PHOTOMETRICS

P9 12°

Input Power	2.7 W
Color Temperature (CCT)	3000 K
Color Rendering Index (CRI)	80+
Beam Spread	12°
Max Candela Power	1192cd
Delivered Lumens	168
Efficacy	62 lm/W

Polar Graph - Intensity

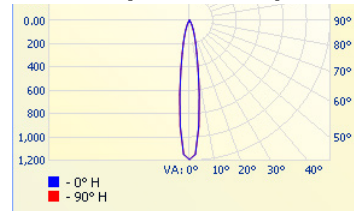

Cone of Light - Illuminance

	Center Beam fc	Beam Width	
8.3R	17.3 fc	2.3 ft	2.3 ft
16.7R	4.28 fc	4.7 ft	4.7 ft
25.0R	1.91 fc	7.0 ft	7.1 ft
33.3R	1.08 fc	9.3 ft	9.4 ft
41.7R	0.69 fc	11.6 ft	11.8 ft
50.0R	0.48 fc	14.0 ft	14.2 ft

■ Vert. Spread: 15.9°
■ Horiz. Spread: 16.1°

P9 25°

Input Power	2.7 W
Color Temperature (CCT)	3000 K
Color Rendering Index (CRI)	80+
Beam Spread	25°
Max Candela Power	736cd
Delivered Lumens	170
Efficacy	63 lm/W

Polar Graph - Intensity

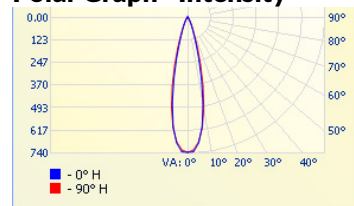

Cone of Light - Illuminance

	Center Beam fc	Beam Width	
8.3R	10.7 fc	3.5 ft	3.8 ft
16.7R	2.64 fc	7.1 ft	7.6 ft
25.0R	1.18 fc	10.7 ft	11.4 ft
33.3R	0.66 fc	14.2 ft	15.2 ft
41.7R	0.42 fc	17.8 ft	19.0 ft
50.0R	0.29 fc	21.4 ft	22.8 ft

■ Vert. Spread: 24.1°
■ Horiz. Spread: 25.7°

P9 40°

Input Power	2.7 W
Color Temperature (CCT)	3000 K
Color Rendering Index (CRI)	80+
Beam Spread	40°
Max Candela Power	588cd
Delivered Lumens	163
Efficacy	60 lm/W

Polar Graph - Intensity

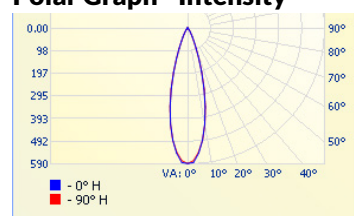

Cone of Light - Illuminance

	Center Beam fc	Beam Width	
8.3R	8.53 fc	4.2 ft	4.3 ft
16.7R	2.11 fc	8.5 ft	8.6 ft
25.0R	0.94 fc	12.8 ft	12.9 ft
33.3R	0.53 fc	17.0 ft	17.1 ft
41.7R	0.34 fc	21.3 ft	21.4 ft
50.0R	0.24 fc	25.5 ft	25.7 ft

■ Vert. Spread: 28.6°
■ Horiz. Spread: 28.8°

P9 60°

Input Power	2.7 W
Color Temperature (CCT)	3000 K
Color Rendering Index (CRI)	80+
Beam Spread	60°
Max Candela Power	255cd
Delivered Lumens	140
Efficacy	52 lm/W

Polar Graph - Intensity

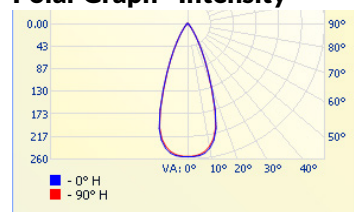

Cone of Light - Illuminance

	Center Beam fc	Beam Width	
8.3R	3.7 fc	6.2 ft	6.2 ft
16.7R	0.91 fc	12.6 ft	12.5 ft
25.0R	0.41 fc	18.8 ft	18.7 ft
33.3R	0.23 fc	25.0 ft	24.9 ft
41.7R	0.15 fc	31.4 ft	31.1 ft
50.0R	0.1 fc	37.6 ft	37.3 ft

■ Vert. Spread: 41.2°
■ Horiz. Spread: 40.9°

CCT Multiplier

Color Temperature	Multiplier
2700 K	.97
3000 K	1.00
4000 K	1.05

Resources

[P9 Path Light – IES Version \(ZIP\)](#)

[P9 Path Light – PDF Version \(ZIP\)](#)

[Submit IES File Request](#)

Standard IES files typically represent the highest wattage, 3000K CCT, and available optics. For other configurations, submit one fixture variation per request.

[P9 Path Light – Install Guide](#)

Product Page / IES Files / Online Ordering:

gardenlightled.com/product/p9-path-light/

Warranty Information:

gardenlightled.com/warranty/