

# X5 | HIGH POWER SPOTLIGHT



DIRECTIONAL & ACCENT | X Series | 2.25"Ø  
 12-21W (1200 - 2000lm) | 10.5-18VAC | Integrated LED

## FEATURES

- U.S.-made light engine.
- CNC-machined, corrosion-resistant 6061 aluminum; IP67 rated.
- Vertical heat sink enhances thermal efficiency.
- 240-degree vertical and 360-degree horizontal adjustable knuckle.
- Serviceable and upgradeable light engine for future technology enhancements.
- Dimmable configurations available; see Specifications and ordering guide for details. Standard fixtures are non-dimmable.
- Built-in surge protector safeguards internal electronics from voltage fluctuations and power surges.
- Integrated breathable ant guard shields internal components while allowing airflow to prevent insect intrusion.
- High-performance 3-step bin LED with an L70 rating of over 100,000 hours.
- [20-year manufacturer limited warranty.](#)
- ETL listed to the UL 1838 standard, with [IES files available.](#)
- ***The X5 is a built-to-order, non-stock fixture with a 5-7 business day lead time.***



## AVAILABLE FINISHES:

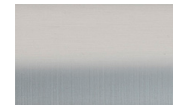

SSA  
Stainless Aluminum



AB  
Architectural Bronze



BLK  
Black

## APPLICATION NOTES

### \*Uplighting Only

Fixture can be built for downlighting applications upon request.

## POWER CONSUMPTION

COLOR TEMPERATURE	WATTAGE	VA	LUMENS	ADDITIONAL COLOR TEMP OPTIONS	
● 3000K	12W	18VA	1200LM	● 2700K	● 5000K
	15W	22VA	1500LM		
	18W	27VA	1800LM		
	21W	32VA	2000LM		

## SPECIFICATIONS

### Materials

CNC-machined from billet 6061-T6 aluminum with 304 stainless hardware.

### Finish

**SSA:** Marine-grade anodization for lasting corrosion resistance and durability.

**BLK/AB:** Corrosion-resistant E-coat primer under a hard enamel finish that delivers strong UV protection.

### Shroud Options

Compression-fit bezel with dual O-ring seal, supporting two interchangeable shroud profiles, precision-machined to match the fixture finish and optical performance (See page 2 for details).

### Wattage

12, 15, 18 or 21W CREE LED delivering up to 2000lm.

### Voltage

10.5-18VAC. Requires low voltage transformer or step down transformer.

### Light Engine

Integrated design, field-replaceable – USA-built metal core LED module. Standard CRI 80 (CRI 90 optional). CCT: 2700K & 3000K (others available). Mac-Adam 3-step binning for consistent color.

### Optics

Interchangeable optics available in 16°, 27°, 42°, and 78° beam angles.

### Lead Wire

39" 18 AWG tinned copper

### Dimming Options

DC phase dimming, TRIAC/ELV, and 0 to 10 V constant current supported with specified drivers. Compatible with Lutron, Crestron, and Control4 when specified.

### Mounting

Comes standard with the LV180 stake and mounts using 1/2"-14 NPS fittings, fully compatible with all Garden Light LED mounting accessories. (See page 2 for details)

### Listings

ETL listed to UL1838, IP67 Standard.









# X5 | X Series Spotlight

DIRECTIONAL & ACCENT

## ORDERING GUIDE

EXAMPLE: X5-DIM-78-AB-NSHR AB-HCL-LV 180

### MODEL

<b>X5</b>				
X5 Directional & Accent Light Fully Integrated	<b>WATTAGE</b>	<b>OPTICS</b>	<b>FINISH</b>	<b>COLOR TEMPERATURE</b>
	12   (12W)	16   (17°)	 AB   (Architectural Bronze)	 3000K   (Default/Blank)
	15   (15W)	27   (27°)	 BLK   (Black)	 2700K
	18   (18W)	42   (42°)	 SSA   (Stainless Aluminum)	 5000K
	21   (21W)	78   (78°)		
	DIM   (Dimmable)			

## OPTIONAL ACCESSORIES

<b>SHROUD</b>
FSHR XXX   (Flat Shroud (Included/Blank))
NSHR XXX   (34.5° Shroud)

<b>LOUVER</b>
HCL   (Hex Cell Louver)

### Mounting

<b>GROUND MOUNT</b>
LV180   (LV180 Stake (Included/Blank))
LV150   (LV150 Heavy Duty Stake 4"D X 19"H)
<b>SURFACE MOUNT</b>
MMB XXX   (Mini Universal Mounting Base 2.375" Diameter x 1" H)
<b>TREE MOUNT</b>
TMAB   (Tree Mount)
TMSTR3   (Tree Mount Strap 3')
TMSTR5   (Tree Mount Strap 5')

<b>Extensions</b>
EXT6 XXX   (6" Extension)
EXT12 XXX   (12" Extension)
EXT20 XXX   (20" Extension)
EXT30 XXX   (30" Extension)

\* XXX represents color/finish option



# X5 | X Series Spotlight

DIRECTIONAL & ACCENT

## FIXTURE DRAWINGS

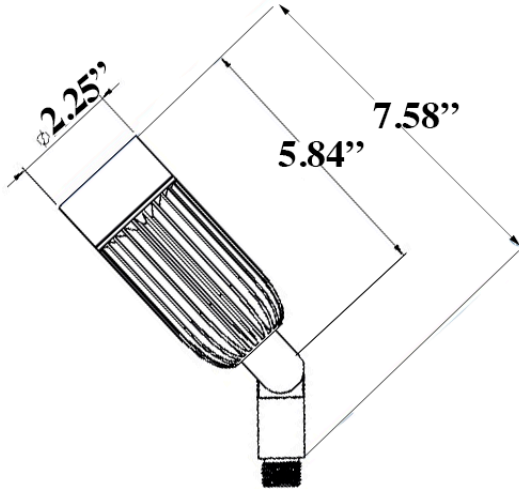

## OPTIONS & ACCESSORIES

Shroud Options:



FLAT SHROUD



34.5° SHROUD

Louver Options:

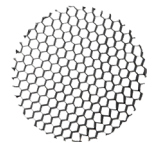

HONEY COMB LOUVER

Extensions:



[6" EXTENSION](#)



[12" EXTENSION](#)



[20" EXTENSION](#)

## MOUNTING OPTIONS

Ground Mount:



[LV180 STAKE](#)



[LV150 STAKE](#)

Surface Mount:



[MINI UNI MOUNTING BASE](#)

Tree Mount:



[TREE MOUNT](#)



[STRAP 3'](#)



[STRAP 5'](#)