



DATE:

PROJECT:

TYPE:

CATALOG:

# WL | WELL LIGHT

IN-GRADE & WELL LIGHTS | In-Grade Series | 4.00"Ø

2 - 9W (195 - 810lm) | 10.5-18 VAC | Integrated LED



## FEATURES

- U.S.-made light engine and driver.
- CNC-machined, corrosion-resistant 6061 aluminum or C360 Brass; IP67 rated.
- Dimmable configurations available; see Specifications and ordering guide for details. Standard fixtures are non-dimmable.
- Serviceable and upgradeable light engine for future technology enhancements.
- Optional factory-installed hex louver available to reduce glare and direct source visibility in direct-view applications.
- PVC mounting sleeve included – 2-7/8" I.D. x 10" L; suitable for pre-pour concrete installations, protects fixture during concrete placement and backfill, and facilitates future service.
- Built-in surge protector safeguards internal electronics from voltage fluctuations and power surges.
- High-performance 3-step bin LED with an L70 rating of over 100,000 hours.
- [20-year manufacturer limited warranty.](#)
- ETL listed to the UL 1838 standard, with IES Files Available (See page 4).
- 3000K fixtures available in all finishes, wattages, and optics, in stock and ready to ship. Other color temperatures are non-stock and require a lead time of 3-5 business days.

## AVAILABLE FINISHES:



BR  
Brass

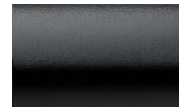

OBLK  
Omega Black

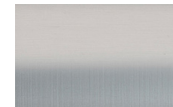

SSA  
Stainless Aluminum

## POWER CONSUMPTION

*Candela Power & IES charts can be found on page 4*

COLOR TEMPERATURE	WATTAGE	VA	LUMENS	ADDITIONAL COLOR TEMP OPTIONS	
● 3000K*	2W	4VA	195LM	● 2700K	● 5000K
	4W	7VA	405LM	● Amber**	● Blue
	6W	10VA	600LM	● Royal Blue	● Green
	9W	15VA	810LM	● Red**	● Fuchsia
				● Lavender	

\* Indicates stocked items. Non-stocked items require 3-5 business days additional lead time, special order deposit and are non-refundable. Fuchsia and Lavender require additional lead time above the standard 3-5 business days. \*\* Amber not available in 6W or 9W and red not available in 9W.

## SPECIFICATIONS

### Materials

CNC-machined from billet 6061-T6 aluminum or C360 brass with 304 stainless hardware.

### Finish

BR: Raw, brushed brass; will tarnish/patina naturally.

Omega Black: Military-grade treatment engineered for harsh/coastal sites with exceptional scratch/corrosion resistance.  
SSA: Marine-grade anodization for lasting corrosion resistance and durability.

### Louver Option

Optional factory-installed hex louver reduces glare and direct source visibility in direct-view applications. Use of louver will result in a reduction of delivered light output.

### Wattage

2, 4, 6 or 9W CREE LED delivering up to 810 lm.

### Voltage

10.5-18VAC. Requires low voltage transformer or step down transformer.

### Light Engine

Integrated design, field-replaceable – USA-built metal core LED module. Standard CRI 80 (CRI 90 optional). CCT: 2700K & 3000K (others available). Mac-Adam 3-step binning for consistent color.

### Optics

Interchangeable optics available in 12°, 25°, 40°, and 60° beam angles.

### Lead Wire

58" 18 AWG SJEOOW tinned copper.

### Dimming Options

Dimmable configurations support DC phase dimming (TRIAC/ELV) and 0 to 10 V constant current with specified drivers, compatible with Lutron, Crestron, and Control4 when specified. Standard fixtures are non dimmable. For full dimmable options, contact your sales rep.

### Mounting

In-grade mounting for hardscape and ground-level installations. Direct-in-grade installations require a 2-9/16 in. core drill. For pre-fab or pre-pour installations, a 10 in. x 2-7/8 in. PVC installation tube is provided as standard for fixture placement prior to concrete or hardscape pour.

### Listings

ETL listed to UL1838, IP67 Standard.



# WL | In-Grade Series

IN-GRADE & WELL LIGHTS

## ORDERING GUIDE

EXAMPLE: WL 204 SSA 2700K HCL

### MODEL

<b>WL</b> WL In-Grade & Accent Light Fully Integrated	<b>WATTAGE</b>	<b>OPTICS</b>	<b>FINISH</b>	<b>COLOR TEMPERATURE</b>
	DIM   (Dimmable)	1   (12°)	BR   (Brass)	3000K   (Default/Blank)
	20   (2W)	2   (25°)	OBLK   (Omega Black)	2700K
	35   (4W)	4   (40°)	SSA   (Stainless Aluminum)	5000K
	50   (6W)	6   (60°)		AMB   (Amber)
	75   (9W)			BLU   (Blue)
				RBL   (Royal Blue)
				GRN   (Green)
				RED   (Red)
				FSA   (Fuchsia)
				LVR   (Lavender)

### OPTIONAL ACCESSORIES

Accessory images & dimensions can be found on page 3

<b>LOUVER</b>	<b>Mounting</b>
HCL   (Hex Cell Louver)	<b>IN-GRADE MOUNT</b>
	WL-SLEEVE   (10" X 2 7/8" PVC WELL LIGHT SLEEVE (Included/Blank))

## TRANSFORMERS

### BUILD THE SKU LEFT → RIGHT

Pattern: [WATTAGE (VA)]-[MODEL]-[CONNECTION TYPE]

Items tagged "(Default/Blank)" are not included in the SKU.

EXAMPLE: 602-WLED SS-DW

<b>WATTAGE (VA)</b>	<b>MODEL</b>	<b>CONNECTION TYPE</b>
62   102   152   302   602   902   1202	WLED SS   (Low Voltage Magnetic Transformer 15V Tap W/ LED & Surge Protection)	Pluggable 120VAC Plug-In   (Default/Blank)   DW   (Direct Wire 120VAC)
60WNL	INLINE   (60W No-Load Inline Electronic Transformer 120VAC Input, 12VAC Output)	Direct Wire 120VAC   (Default/Blank)
60	MD   (Mammoth Dynamics phase-dimmable constant current driver (DC))	Direct Wire 120VAC   (Default/Blank)



## FIXTURE DRAWINGS

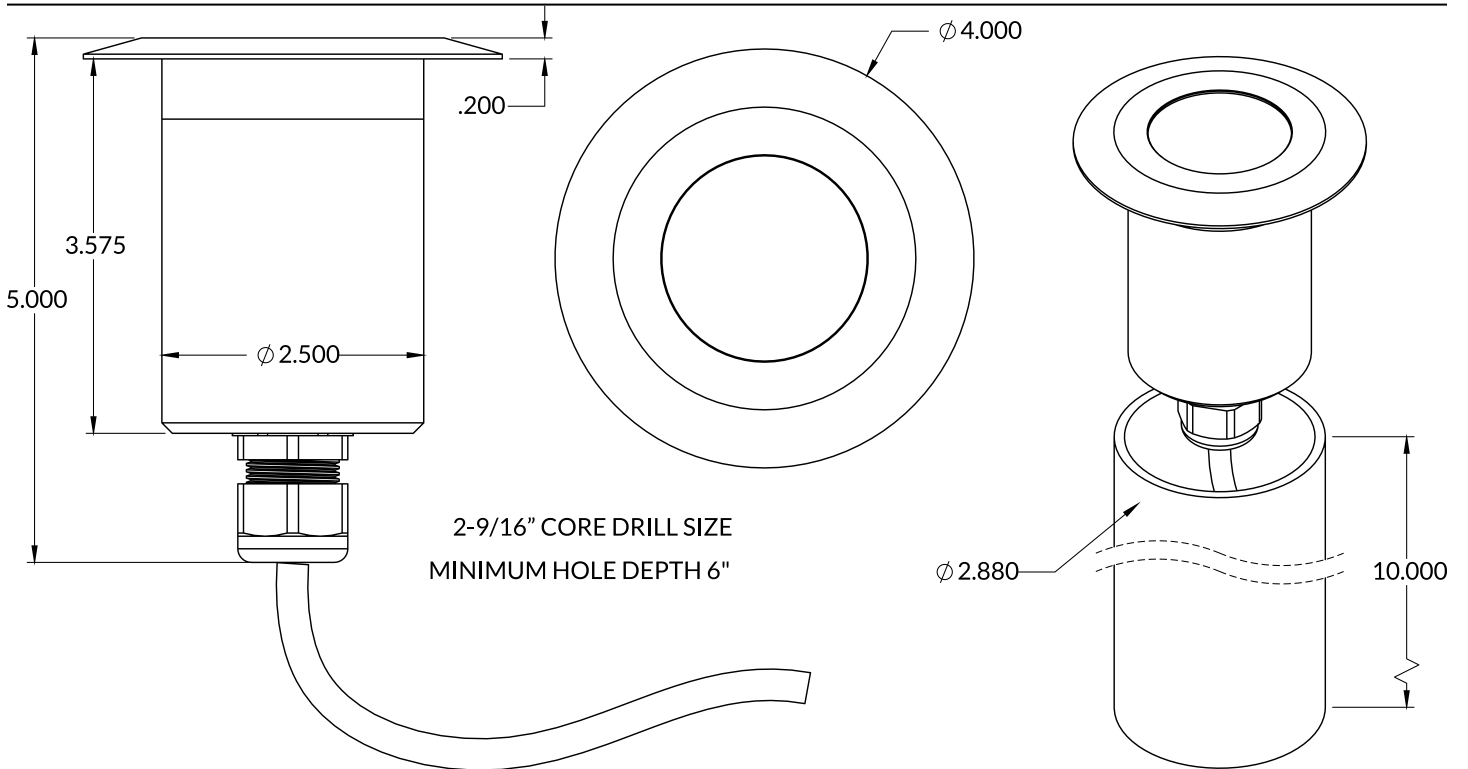

## OPTIONS & ACCESSORIES

Louver Options:

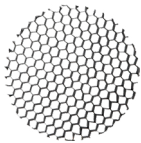

HONEY COMB LOUVER

## MOUNTING OPTIONS

In-Grade Mount:



PVC WL SLEEVE



## PHOTOMETRICS

### WL 12°

Input Power	9 W
Color Temperature (CCT)	3000 K
Color Rendering Index (CRI)	80+
Beam Spread	12°
Max Candela Power	4110cd
Delivered Lumens	799
Efficacy	57 lm/W

### Polar Graph - Intensity

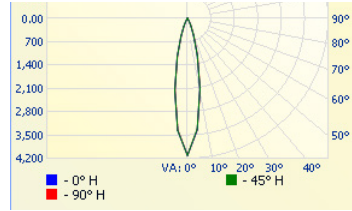

### Cone of Light - Illuminance

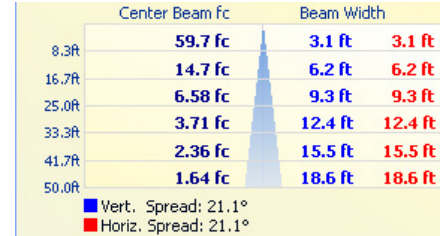

### WL 25°

Input Power	9 W
Color Temperature (CCT)	3000 K
Color Rendering Index (CRI)	80+
Beam Spread	25°
Max Candela Power	2388cd
Delivered Lumens	785
Efficacy	56 lm/W

### Polar Graph - Intensity

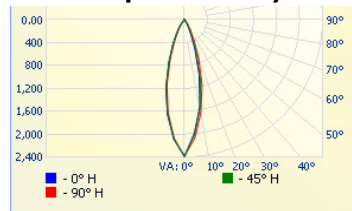

### Cone of Light - Illuminance

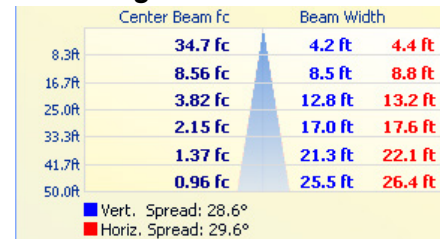

### WL 40°

Input Power	9 W
Color Temperature (CCT)	3000 K
Color Rendering Index (CRI)	80+
Beam Spread	40°
Max Candela Power	1618cd
Delivered Lumens	739
Efficacy	52 lm/W

### Polar Graph - Intensity

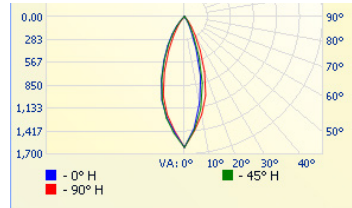

### Cone of Light - Illuminance

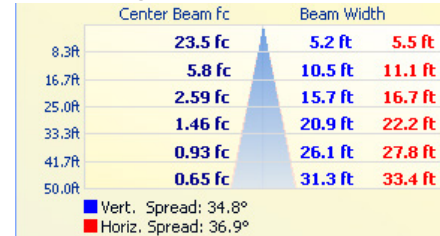

### WL 60°

Input Power	9 W
Color Temperature (CCT)	3000 K
Color Rendering Index (CRI)	80+
Beam Spread	60°
Max Candela Power	1408cd
Delivered Lumens	732
Efficacy	52 lm/W

### Polar Graph - Intensity

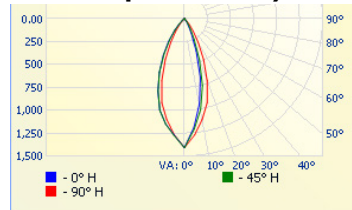

### Cone of Light - Illuminance

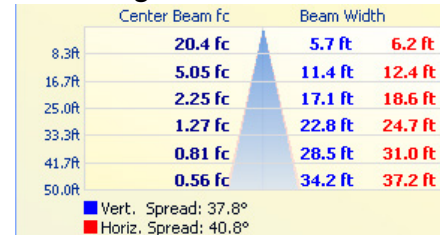

### Wattage Multiplier

Wattage	Multiplier
2 Watt	.24
4 Watt	.50
6 Watt	.74
9 Watt	1.00

### CCT Multiplier

Color Temperature	Multiplier
2700 K	.97
3000 K	1.00
4000 K	1.05

### Resources

<a href="#">Well Light In-Grade Light – IES Version (ZIP)</a>
<a href="#">Well Light In-Grade Light – PDF Version (ZIP)</a>
<a href="#">Well Light In-Grade Light – Install Guide</a>