

V3

DIRECTIONAL & ACCENT | Visionary Series | 2.38"Ø
2 - 9W (195 - 810lm) | 10.5-16 VAC | Integrated LED



FEATURES

- U.S.-made light engine and external driver (3" x 5/8"); driver is fully encapsulated in weatherproof PVC housing (See fixture drawing on page 3 for more details).
- CNC-machined, corrosion-resistant 6061 aluminum; IP66 rated.
- Dimmable configurations available; see Specifications and ordering guide for details. Standard fixtures are non-dimmable.
- Vertical heat sink enhances thermal efficiency.
- 240-degree vertical and 360-degree horizontal adjustable knuckle.
- Serviceable and upgradeable light engine for future technology enhancements.
- Built-in surge protector safeguards internal electronics from voltage fluctuations and power surges.
- Integrated breathable ant guard shields internal components while allowing airflow to prevent insect intrusion.
- High-performance 3-step bin LED with an L70 rating of over 100,000 hours.
- [20-year manufacturer limited warranty.](#)
- ETL listed to the UL 1838 standard, with IES files available (See page 4).
- 3000K fixtures available in all finishes, wattages, and optics, in stock and ready to ship. Other color temperatures are non-stock and require a lead time of 5-7 business days.



AVAILABLE FINISHES:

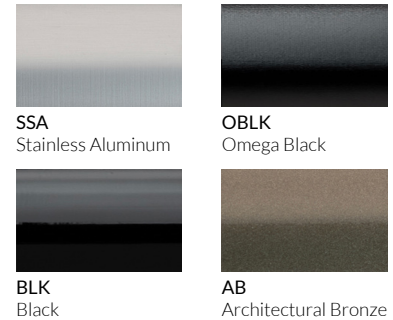

POWER CONSUMPTION

Candela Power & IES charts can be found on page 4

COLOR TEMPERATURE	WATTAGE	VA	LUMENS	ADDITIONAL COLOR TEMP OPTIONS	
● 3000K*	2W	4VA	195LM	● 2700K	● 5000K
	4W	7VA	405LM	● Amber***	● Blue
	6W	10VA	600LM	● Royal Blue	● Green
	9W	15VA	810LM	● Red**	● Fuchsia
	9W	15VA	1000LM ++	● Lavender	

++ Ask your sales rep about the custom-build 1000LM option.
* Indicates stocked items. Non-stocked items require 5-7 business days additional lead time, special order deposit and are non-refundable. Fuchsia and Lavender require additional lead time above the standard 5-7 business days.

** Amber not available in 6W or 9W and red not available in 9W.
* Amber option does not indicate turtle-friendly certification. Refer only to fixtures specifically identified as Turtle-friendly for certified applications.

SPECIFICATIONS

Materials

CNC-machined from billet 6061-T6 aluminum with 316 stainless hardware.

Finish

SSA: Marine-grade anodization for lasting corrosion resistance and durability.

BLK/AB: Corrosion-resistant E-coat primer under a hard enamel finish that delivers strong UV protection.

Omega Black: Military-grade treatment engineered for harsh/coastal sites with exceptional scratch/corrosion resistance.

Shroud Options

Equipped with our Lock-In-Load (LNL) system, each fixture supports five swappable shroud styles—all machined to match finish and performance (See page 2 for details).

Wattage

2, 4, 6 or 9W delivering up to 810 lm; 1,000 lm custom-build on request—contact your sales rep.

Voltage

10.5-16VAC. Requires low voltage transformer or step down transformer.

Light Engine

US Built Led module with Cree Diode and Metal core PCB for better heat dissipation.
CRI 80 (CRI 90 upon request) CCT 2700K & 3000K. McAdam 3 step LED binning to ensure color consistency.

Optics

Interchangeable optics available in 12°, 25°, 40°, and 60° beam angles.

Lead Wire

36" 18 AWG tinned copper

Dimming Options

Standard fixtures are non dimmable. Dimmable Option valuable with constant current LED power supply connected in series with the fixtures.

Dimming Method: Phase Dimming (TRI-AC/ELV) or 0-10V dimming.

Mounting

Comes standard with the LV180 stake and mounts using 1/2"-14 NPS fittings, fully compatible with all Garden Light LED mounting accessories. (See page 2 for details)

Certifications & Ratings

ETL listed to UL1838, IP66 Standard.

APPLICATION NOTES

*Uplighting Only

Fixture can be built for downlighting applications upon request.



V3 | Visionary Series Spotlight

DIRECTIONAL & ACCENT | VISIONARY

ORDERING GUIDE

EXAMPLE: V3 204 AB 2700K LNL SHR45 AB HCL MMB AB

MODEL

V3 V3 Directional & Accent Light Fully Integrated	WATTAGE	OPTICS	FINISH	COLOR TEMPERATURE	LNL LNL (Lock-N-Load Shroud - Standard)
	DIM (Dimmable)	1 (12°)	AB (Architectural Bronze)	3000K (Default/Blank)	
	20 (2W)	2 (25°)	BLK (Black)	2700K	
	35 (4W)	4 (40°)	OBLK (Omega Black)	5000K	
	50 (6W)	6 (60°)	SSA (Stainless Aluminum)	AMB (Amber)	
	75 (9W)			BLU (Blue)	
	75C (9W - 1000LM)			RBL (Royal Blue)	
				GRN (Green)	
			RED (Red)		
			FSA (Fuchsia)		
			LVR (Lavender)		

OPTIONAL ACCESSORIES

Accessory images & dimensions can be found on page 3

SHROUD SHR345 XXX (34.5° Shroud (Included/Blank)) SHR45 XXX (45° Shroud) SHREX58 XXX (Extended 58° Shroud) SHRJLM XXX (JLM Shroud) SHRFLT XXX (Flat Shroud)	LOUVER HCL (Hex Cell Louver)	Mounting GROUND MOUNT LV180 (LV180 Stake (Included/Blank)) LV150 (LV150 Heavy Duty Stake 4"D X 19"H) SURFACE MOUNT MMB XXX (Mini Universal Mounting Base 2.375" Diameter x 1" H) TREE MOUNT TMAB (Tree Mount) TMSTR3 (Tree Mount Strap 3') TMSTR5 (Tree Mount Strap 5')
Extensions EXT6 XXX (6" Extension) EXT12 XXX (12" Extension) EXT20 XXX (20" Extension) EXT30 XXX (30" Extension)		

* XXX represents color/finish option

TRANSFORMERS

BUILD THE SKU LEFT → RIGHT

Pattern: [WATTAGE (VA)]-[MODEL]-[CONNECTION TYPE]

Items tagged "(Default/Blank)" are not included in the SKU.

EXAMPLE: 602-WLED SS-DW

WATTAGE (VA) 62 102 152 302 602 902 1202	MODEL WLED SS (Low Voltage Magnetic Transformer 15V Tap W/ LED & Surge Protection)	CONNECTION TYPE Pluggable 120VAC Plug-In (Default/Blank) DW (Direct Wire 120VAC)
60WNL	INLINE (60W No-Load Inline Electronic Transformer 120VAC Input, 12VAC Output)	Direct Wire 120VAC (Default/Blank)
60	MD (Mammoth Dynamics phase-dimmable constant current driver (DC))	Direct Wire 120VAC (Default/Blank)



V3 | Visionary Series Spotlight

DIRECTIONAL & ACCENT | VISIONARY

FIXTURE DRAWINGS

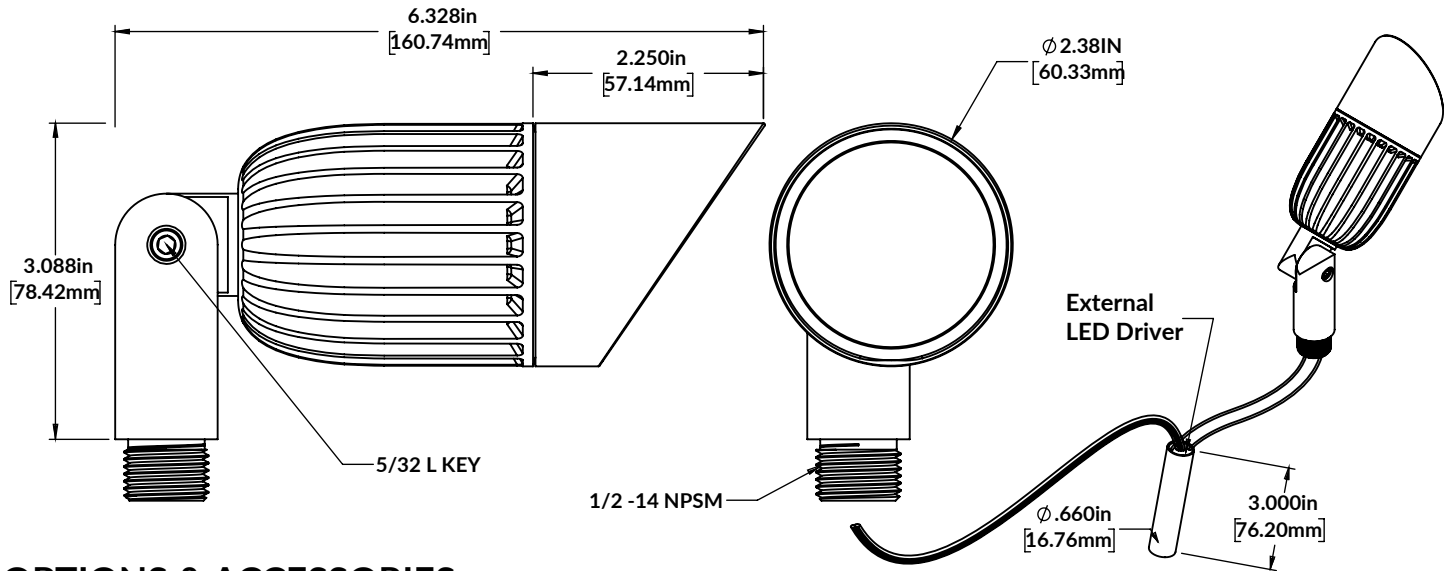

OPTIONS & ACCESSORIES

Shroud Options:



Louver Options:

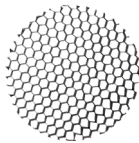

HONEY COMB LOUVER

Extensions:



[6" EXTENSION](#) [12" EXTENSION](#) [20" EXTENSION](#)

MOUNTING OPTIONS

Ground Mount:



[LV180 STAKE](#)

[LV150 STAKE](#)

Building/
Structure Mount:



[MINI UNI MOUNTING BASE](#)

Tree Mount:



[TREE MOUNT](#)

[STRAP 3'](#)

[STRAP 5'](#)



V3 | Visionary Series Spotlight

DIRECTIONAL & ACCENT | VISIONARY

PHOTOMETRICS

V3 12°

Input Power	9 W
Color Temperature (CCT)	3000 K
Color Rendering Index (CRI)	80+
Beam Spread	12°
Max Candela Power	12090cd
Delivered Lumens	729
Efficacy	73 lm/W

Polar Graph - Intensity

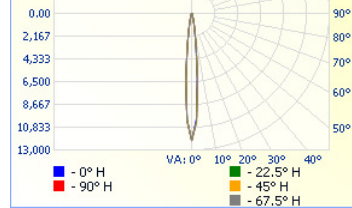

Cone of Light - Illuminance

	Center Beam fc	Beam Width	
8.3R	176 fc	1.5 ft	1.5 ft
16.7R	43.4 fc	3.0 ft	3.0 ft
25.0R	19.3 fc	4.5 ft	4.6 ft
33.3R	10.9 fc	6.0 ft	6.1 ft
41.7R	6.95 fc	7.6 ft	7.6 ft
50.0R	4.84 fc	9.1 ft	9.1 ft

Vert. Spread: 10.4°
Horiz. Spread: 10.4°

V3 25°

Input Power	9 W
Color Temperature (CCT)	3000 K
Color Rendering Index (CRI)	80+
Beam Spread	25°
Max Candela Power	3076cd
Delivered Lumens	733
Efficacy	74 lm/W

Polar Graph - Intensity

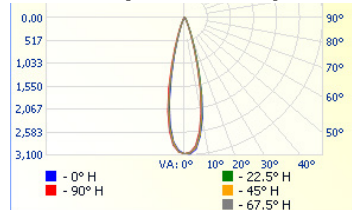

Cone of Light - Illuminance

	Center Beam fc	Beam Width	
8.3R	44.6 fc	3.7 ft	3.8 ft
16.7R	11 fc	7.5 ft	7.6 ft
25.0R	4.91 fc	11.3 ft	11.4 ft
33.3R	2.77 fc	15.0 ft	15.1 ft
41.7R	1.77 fc	18.8 ft	19.0 ft
50.0R	1.23 fc	22.6 ft	22.7 ft

Vert. Spread: 25.4°
Horiz. Spread: 25.6°

V3 40°

Input Power	9 W
Color Temperature (CCT)	3000 K
Color Rendering Index (CRI)	80+
Beam Spread	40°
Max Candela Power	2094cd
Delivered Lumens	810
Efficacy	81 lm/W

Polar Graph - Intensity

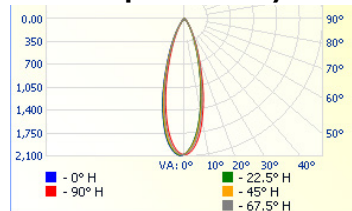

Cone of Light - Illuminance

	Center Beam fc	Beam Width	
8.3R	30.1 fc	4.6 ft	4.6 ft
16.7R	7.43 fc	9.3 ft	9.3 ft
25.0R	3.32 fc	13.9 ft	13.9 ft
33.3R	1.87 fc	18.6 ft	18.5 ft
41.7R	1.19 fc	23.2 ft	23.2 ft
50.0R	0.83 fc	27.9 ft	27.8 ft

Vert. Spread: 31.1°
Horiz. Spread: 31.0°

V3 60°

Input Power	9 W
Color Temperature (CCT)	3000 K
Color Rendering Index (CRI)	80+
Beam Spread	60°
Max Candela Power	1295cd
Delivered Lumens	746
Efficacy	75 lm/W

Polar Graph - Intensity

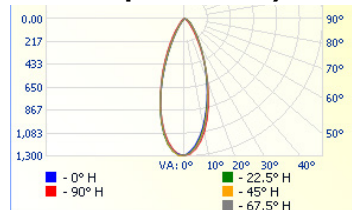

Cone of Light - Illuminance

	Center Beam fc	Beam Width	
8.3R	18.8 fc	5.8 ft	6.0 ft
16.7R	4.64 fc	11.6 ft	12.0 ft
25.0R	2.07 fc	17.4 ft	18.0 ft
33.3R	1.17 fc	23.2 ft	23.9 ft
41.7R	0.74 fc	29.0 ft	29.9 ft
50.0R	0.52 fc	34.8 ft	35.9 ft

Vert. Spread: 38.4°
Horiz. Spread: 39.5°

Wattage Multiplier

Wattage	Multiplier
2 Watt	.24
4 Watt	.50
6 Watt	.74
9 Watt	1.00

CCT Multiplier

Color Temperature	Multiplier
2700 K	.97
3000 K	1.00
4000 K	1.05

Resources

[V3 Visionary Series Spotlight — IES Version \(ZIP\)](#)

[V3 Visionary Series Spotlight — PDF Version \(ZIP\)](#)

[Submit IES File Request](#)

Standard IES files typically represent the highest wattage, 3000K CCT, and available optics. For other configurations, submit one fixture variation per request.

[V3 Visionary Series Spotlight — Install Guide](#)

Product Page / IES Files / Online Ordering:

gardenlightled.com/product/visionary-3-series/

Warranty Information:

gardenlightled.com/warranty/